

Slak SYSTEM

- Kit scorrevole "Slak" a due ante - fissaggio su muro.
- Kit "Slak" para dos puertas - fijación en la pared.
- Two-leaves "Slak" sliding doors kit - wall mount.
- Set Schiebetüren "Slak" mit zwei Flügeln - Befestigung an der Wand.
- Kit coulissant "Slak" pour 2 vantaux - fixation sur mur + fixé dans le verre.

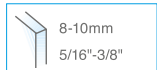

OPTIONAL
 Foro vetro Ø 10
 Hoje en el vidrio Ø 10
 Glass hole Ø 10
 Glasbohrung Ø 10
 Perçage Ø 10

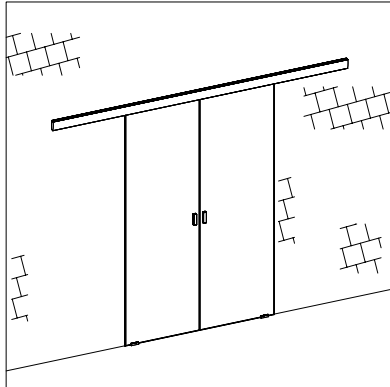
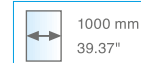
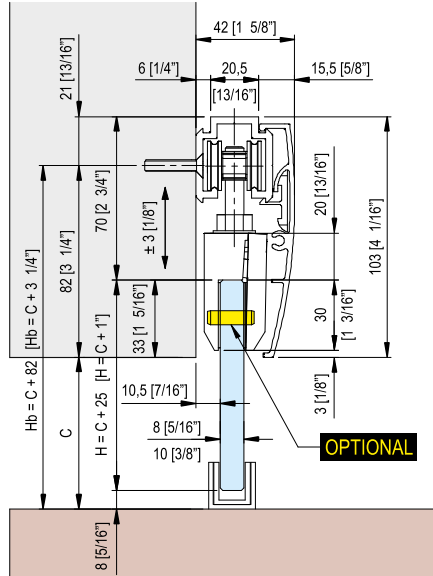

B905 + BS10 STANDARD

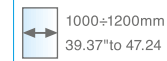
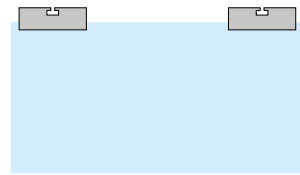
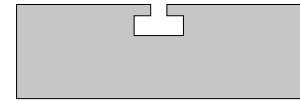

B905 + BS10 + OPTIONAL

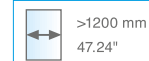
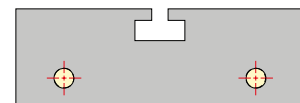

+N B905 + BS10 + OPTIONAL

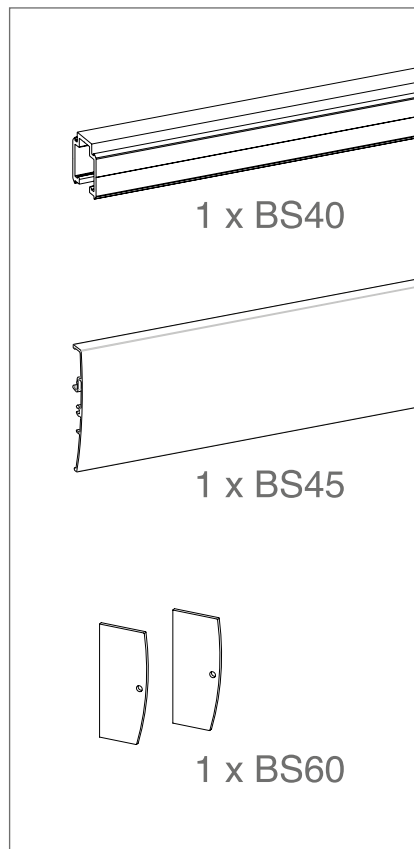
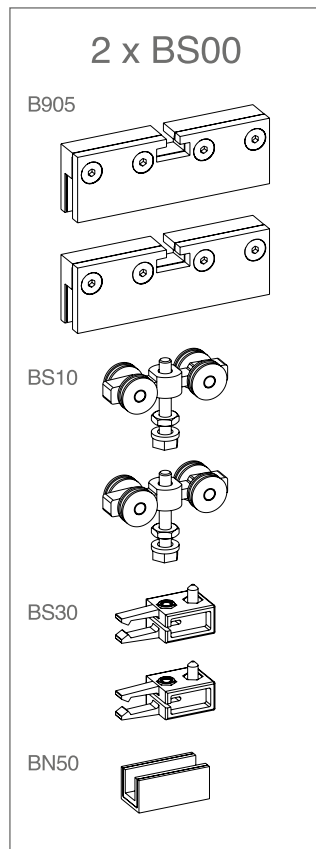
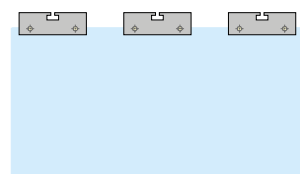
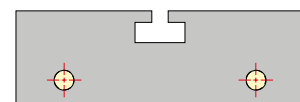

Slak SYSTEM

- Kit scorrevole "Slak" ad un anta -fissaggio su muro + fisso in vetro.
- Kit "Slak" para una puerta - fijación en la pared y vidrio fijo.
- One-leaf "Slak" sliding door kit – wall mount + one fixed glass.
- Set Schiebetüren "Slak" mit einem Flügel - Befestigung an der Wand + einen Sitenteil.
- Kit coulissant "Slak" pour 1 vantail - fixation sur mur + fixation dans le verre.

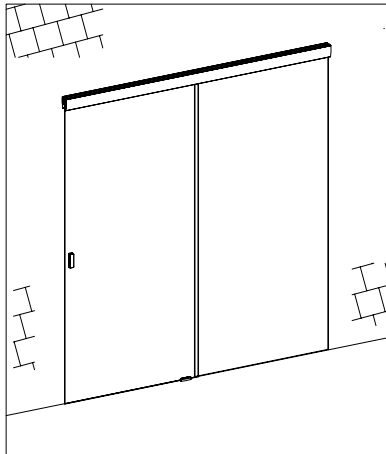

OPTIONAL

Foro vetro Ø 10
 Hoje en el vidrio Ø 10
 Glass hole Ø 10
 Glasbohrung Ø 10
 Percage Ø 10

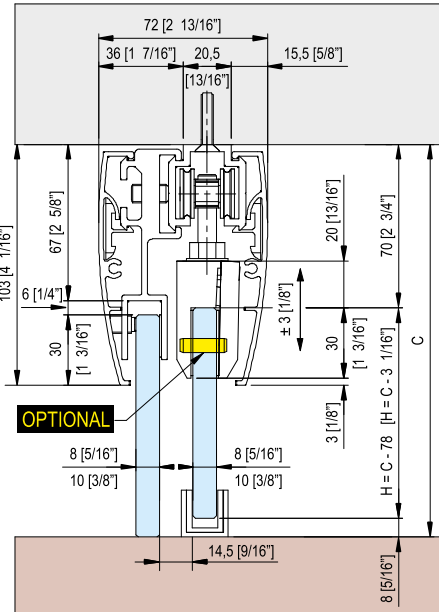

1 x BS00

B905

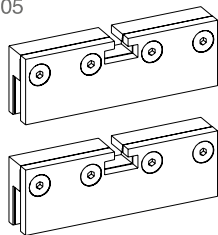

BS10

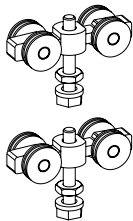

BS30

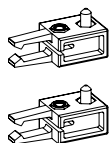

BN50



1 x BS40

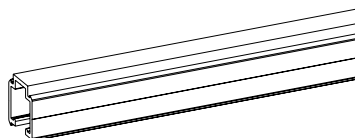

2 x BS45

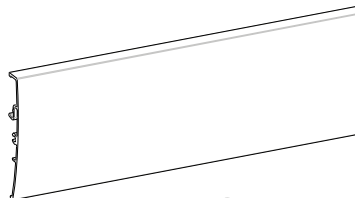

3 x BS70

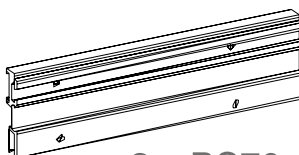

B905 + BS10 STANDARD

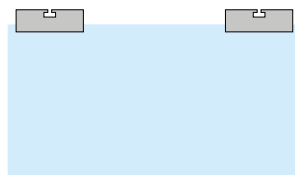
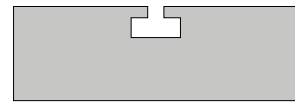

B905 + BS10 + OPTIONAL

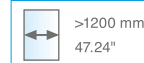
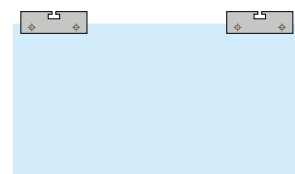
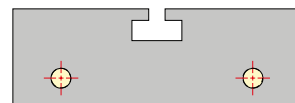

+N B905 + BS10 + OPTIONAL

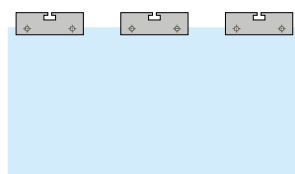
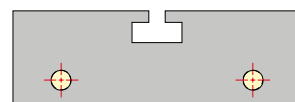

Slak SYSTEM

- Kit scorrevole "Slak" a due ante - fissaggio su muro + 2 fissi in vetro.
- Kit "Slak" para una puerta - fijación en la pared y dos fijos en vidrio.
- Two-leaves "Slak" sliding door kit – wall mount + 2 fixed glasses.
- Set Schiebetüren "Slak" mit zwei Flügeln - Befestigung an der Wand + 2 Seitenteile.
- Kit coulissant "Slak" pour 2 vantaux - fixation sur mur + fixation dans le verre.

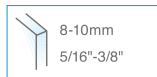
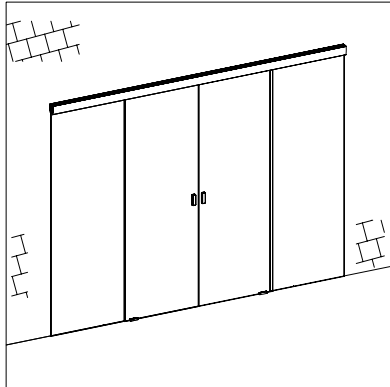

OPTIONAL
 Foro vetro Ø 10
 Hoje en el vidrio Ø 10
 Glass hole Ø 10
 Glasbohrung Ø 10
 Percage Ø 10

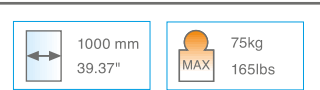
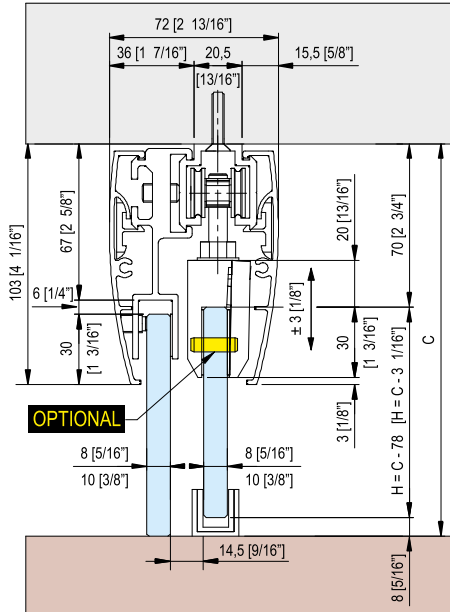

**B905 + BS10
 STANDARD**

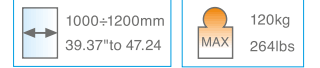
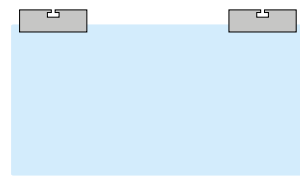
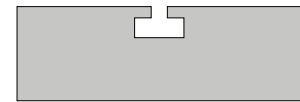

**B905 + BS10
 + OPTIONAL**

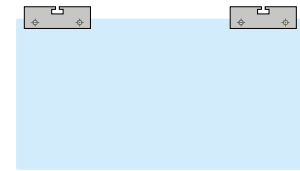
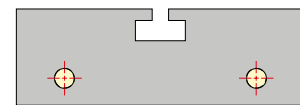

**+N B905 + BS10
 + OPTIONAL**

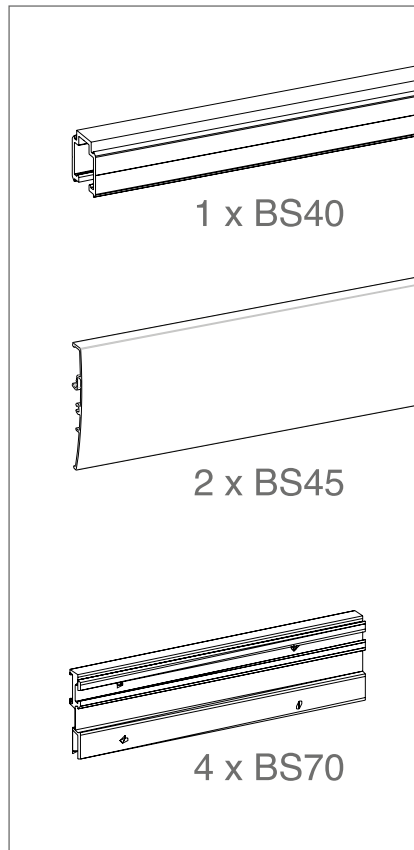
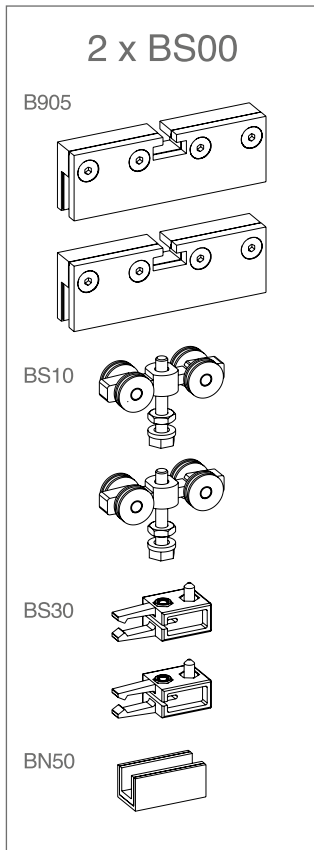
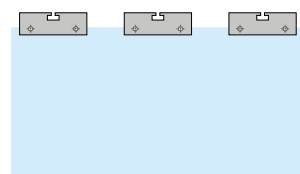
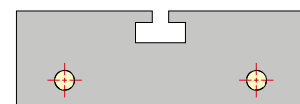

BS40

- Binario Slak L = 2/3/5 mt.
- Vía "Slak" L = 2/3/5 mt.
- Slak rail L = 2/3/5 mt.
- Schiene Slak L = 2/3/5 mt.
- Rail Slak L = 2/3/5 m.

Il binario ha una foratura con passo standard. In caso di taglio potrebbe essere necessario eseguire una foratura ad hoc.

La vía tiene un agujero de "paso" estándar. Cuando corte, deba ejecutar una perforación especial.

The rail has holes with standard spacing. In case of cut, it could be necessary to realize holes ad hoc.

Die Schiene hat Bohrung mit Standardstand. Im Fall von Schnitt könnte es notwendig sein, eine Bohrung ad hoc zu realisieren.

Le rail Slak dispose de trous dont les espaces sont standards. En cas de coupe, il sera peut être nécessaire d'effectuer de nouveaux trous.

Rigatura di posizione fori
Línea de perforación
Line for holes position
Linie für Bohrungenposition
Pré-perçage

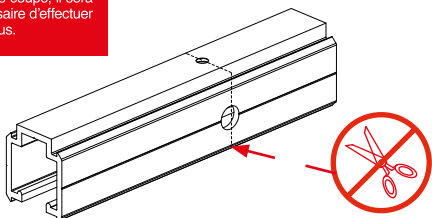
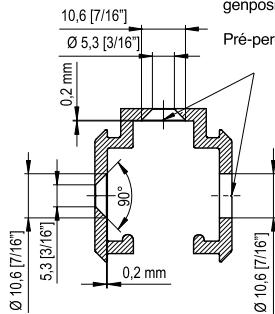

Evitare di accorciare la barra in prossimità dei fori - No acorte la barra cerca de los agujeros. - Avoid to make the bar shorter near the holes - Die Schiene in der Nähe der Bohrungen nicht abkürzen - Éviter de raccourcir la barre à proximité des trous

BS45

- Veletta Slak L = 2/3/5 mt.
- Charter "Slak" L = 2/3/5 mt.
- Slak spandrel panel L = 2/3/5 mt.
- Anlauf Slak L = 2/3/5 mt.
- Capot d'habillage Slak L = 2/3/5 m.

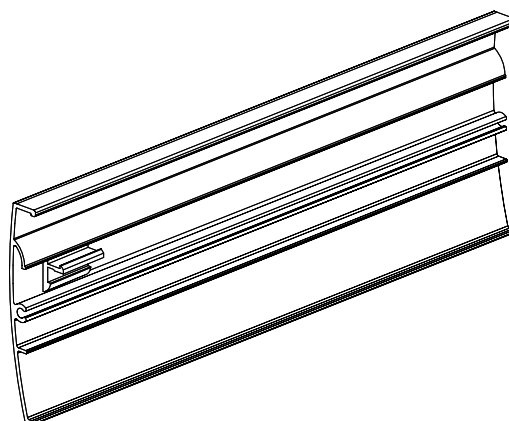
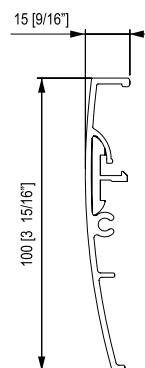

BS60

- Coppia tappi laterali Slak.
- Pareja de tapas laterales Slak.
- Slak double covers.
- Paar Deckel Slak.
- Double cache de finition Slak.

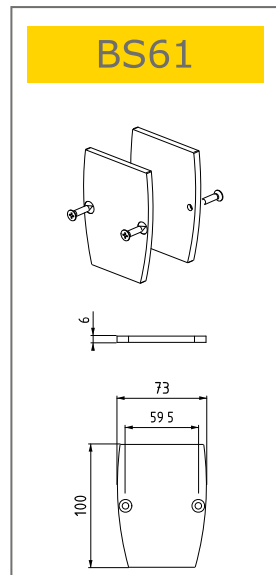
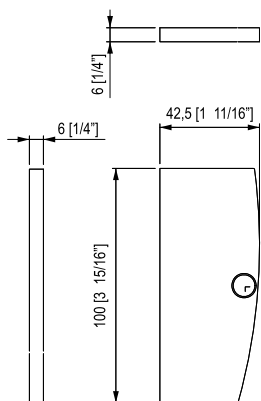

BS70

- Supporto fisso Slak L = 300 mm.
- Soporte Slak de fijo de L = 300 mm.
- Slak fixed support L = 300 mm.
- Schiene für feste Gehäuse L = 300 mm.
- Support fixe Slak L = 300 mm.

