

D05E60N

oildynamic
pivot system

D05E60SOL

free version
without stop

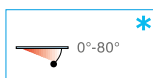
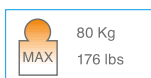
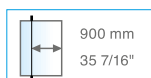

SLASH *oildynamic pivot system*

• Kit Slash per box doccia con 2 spalle in vetro. Stop a +90°.

• Kit Slash de ducha con 2 paneles traseros en cristal. Stop a +90°.

• Slash set for shower tray glass-glass . One door. Stop at +90°.

• Set Slash für Glas-Glas Dusche. Eine Tür. Feststellung +90°.

• Kit Slash avec 2 panneaux en verre et une porte. Arrêt à +90°.

È necessaria una battuta in chiusura in quanto la cerniera ha una precarica - Necesita de un cierre con tope, puesto que la bisagra tiene una precarga - The hinge is preloaded which makes an end stop necessary - Ein Anschlag ist notwendig, da der Beschlag eine Vorspannung besitzt - La charnière a une charge, il est donc nécessaire d'avoir un arrêt de fermeture.

Da specificare all'ordine - Especificar en el pedido - Specify at time of order
Bitte mit der Bestellung genau angeben - Préciser lors de la commande

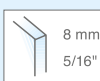

D05E60N/08

D05E60SOL/08

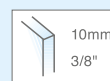

D05E60N/10

D05E60SOL/10

Compresso / Included

OILDYNAMIC
VERSION



D05E P16 (1X)



D05E P11N/08 (1X)
(vetro/glass 8mm)
D05E P11N/10 (1X)
(vetro/glass 10mm)

FREE
VERSION



D05E P16SOL
(1X)



D05E P11SOL/08 (1X)
(vetro/glass 8mm)
D05E P11SOL/10 (1X)
(vetro/glass 10mm)

D05E P12N/08 (1X)
(vetro/glass 8mm)

D05E P12N/10 (1X)
(vetro/glass 10mm)

D05E P47N
(1X)

D05E P80
(2X)

D05E P30N
(1X)

D05E P90
(2X)

Non compreso / Not included

D05E P40/13 (1,25 mt)
L ≤ 1300mm (630mm MIN)

D05E P40/18 (1,75 mt)
L > 1300mm (1800mm MAX)
(1X)

D05E P55N/13 (1,3 mt)
L ≤ 1300mm (630mm MIN)
D05E P55N/18 (1,8 mt)
L > 1300mm (1800mm MAX)
(1X)

D05E P45/09
(0,9 mt)

(1X) L ≤ 900mm
(2X) L > 900mm

D05E P50N
(1X)

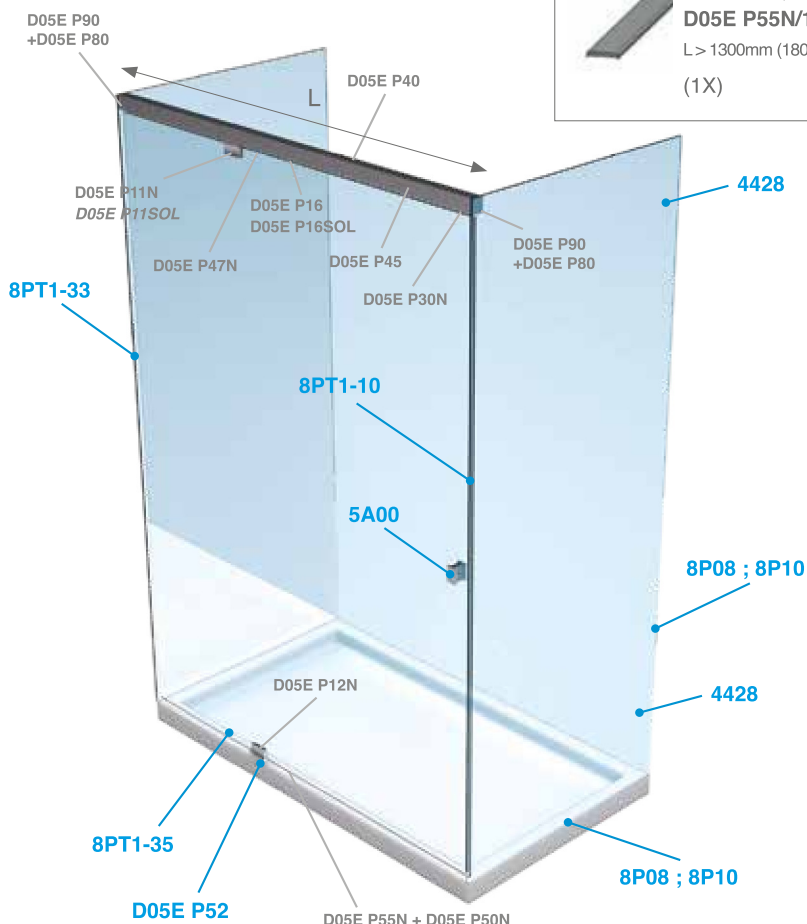

OPTIONAL

Coperture inox per - Cubiertas de acero inoxidable para - Stainless steel covers for - Abdeckungen aus Edelstahl für - Couvertine inox pour

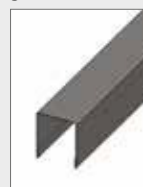

D05E P40

C D05E P40/13
C D05E P40/18
(1X)



D05E P90

C D05E P90
(1X)

Profilo deviatore antischiacciamento - Perfil desviador anti aplastamiento - Seal against finger crush Fingerklemmschutzprofil - Joint anti-pincement



8PT1-33
(1X)



D05E P52
(1X)

D05E60N

D05E60SOL

SLASH system

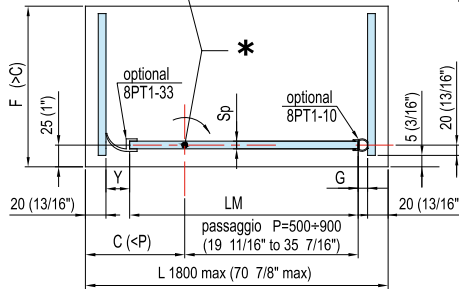
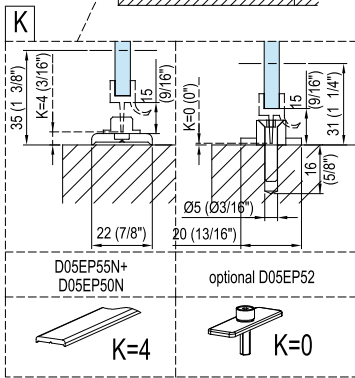
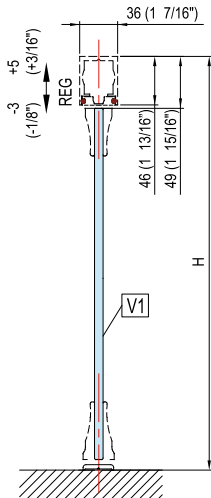
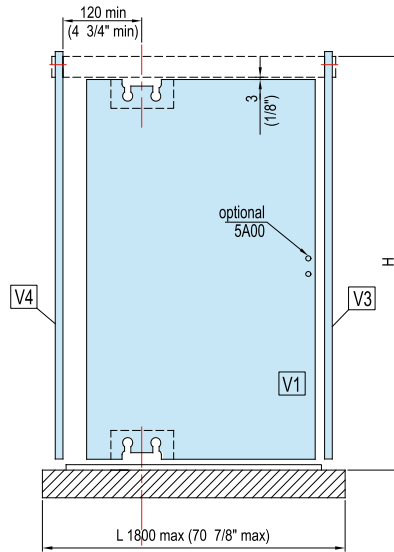
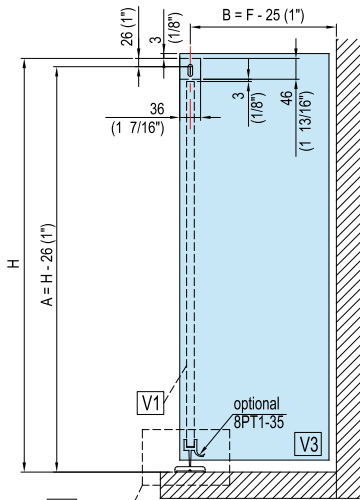

* CENTRO DI ROTAZIONE
PUNTO DE ROTACION
ROTATION POINT
LAGE DER DREHACHSE

Sp	Y	G
8 (5/16")	18 (23/32")	6 (1/4")
10 (3/8")	18 (23/32")	8 (5/16")

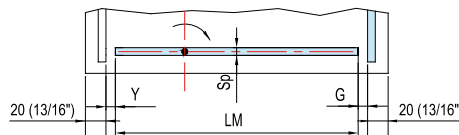
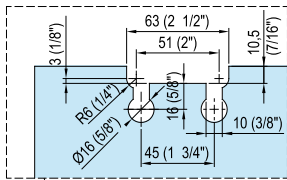

Sp	Y	G
8 (5/16")	3 (1/8")	3 (1/8")
10 (3/8")	3 (1/8")	3 (1/8")

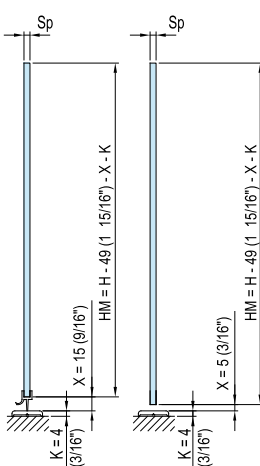
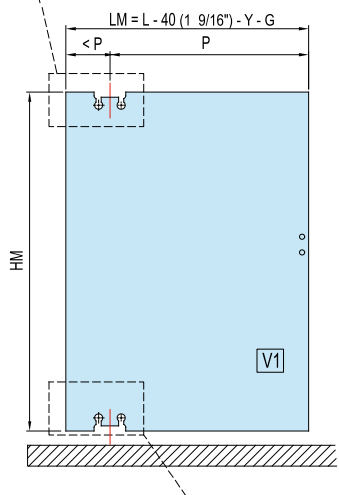

* Definire il passaggio P voluto. Valutare il centro di rotazione e definire la larghezza LM totale.
Definir el pasaje P deseado. El centro de la vuelta de evaluar y definir el ancho total LM.
Define the desired passage P. Consider the rotation point and define the total width LM.
Den gewünschte Durchgang P definieren. Auf den Drehpunkt achten und die Gesamtbreite LM definieren.
Définir le passage P souhaité. Evaluer le centre de rotation et définir la largeur LM totale.

