



ACCESSOIRES
ACCESSORIES



SERRURE DE COIN RÉVERSIBLE REVERSIBLE CORNER LOCK	10.3
CYLINDRE EUROPÉEN EUROPEAN CYLINDER	10.3
GÂCHE DE SOL POUR SERRURE FLOOR STRIKER PLATE FOR LOCK ..	10.3
SERRURE CAVALIER SANS ENCOCHE AVEC CYLINDRE CAVALIER LOCK, WITHOUT NOTCH, WITH CYLINDER ..	10.3
LOCQUET POUR PORTE EN VERRE LATCH FOR GLASS DOOR	10.4
PROFIL DE SERRAGE DU VERRE POUR PANNEAU FIXE AVEC CACHE GLASS TIGHTENING PROFILE FOR FIXED PANEL WITH COVER	10.4
PROFILS U PLIÉ FOLDED U-SECTION	10.5
CLÉS DE SERRAGE TIGHTENING WRENCHES	10.6
SUPPORTS D'ÉTAGÈRES SHELF SYSTEM	10.7

Différents accessoires vous sont proposés de manière à adapter l'installation aux contraintes de votre projet.

Many accessories are available to help you finalize your installation whatever the requirements.

FICHES TECHNIQUES SUR
sadev.com
TECHNICAL INFORMATION ON
sadev.com

PHOTO PHOTO	ENCOMBREMENT DIMENSIONS	EPAISSEUR DE VERRE GLASS THICKNESS	RÉFÉRENCE REFERENCE
----------------	----------------------------	---------------------------------------	------------------------

Serrure de coin réversible / Reversible corner lock

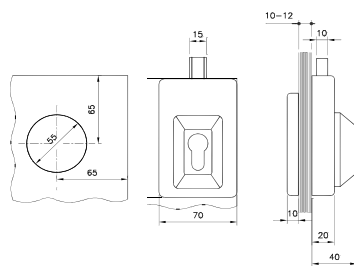

8 mm **09 90 542-215-08**

10 mm **09 90 542-215-10**

12 mm **09 90 542-215-12**

SCHÉMA DRAWING	RÉFÉRENCE REFERENCE
-------------------	------------------------

Cylindre européen ht 59 mm / European cylinder, height 59 mm

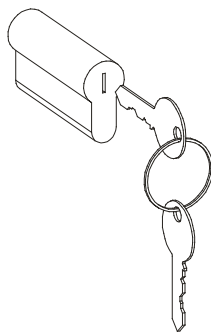

09 90 V017-30

Gâche de sol pour serrure V542 / Floor striker plate for lock V542

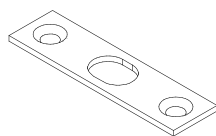

09 90 542-GA

PHOTO PHOTO	EPAISSEUR DE VERRE GLASS THICKNESS	RÉFÉRENCE REFERENCE
----------------	---------------------------------------	------------------------

Serrure cavalier sans encoche avec cylindre / Cavalier lock, without notch, with cylinder



10 mm

09 90 1435-31

Autres épaisseurs de verre sur commande / Other glass thicknesses on order
Plus d'informations techniques sur sadev.com / More information on sadev.com

i FICHES TECHNIQUES SUR sadev.com
TECHNICAL INFORMATION ON sadev.com

PHOTO PHOTO	ENCOMBREMENT DIMENSIONS	EPAISSEUR DE VERRE GLASS THICKNESS	RÉFÉRENCE REFERENCE
Locquet pour porte en verre / Latch for glass door			

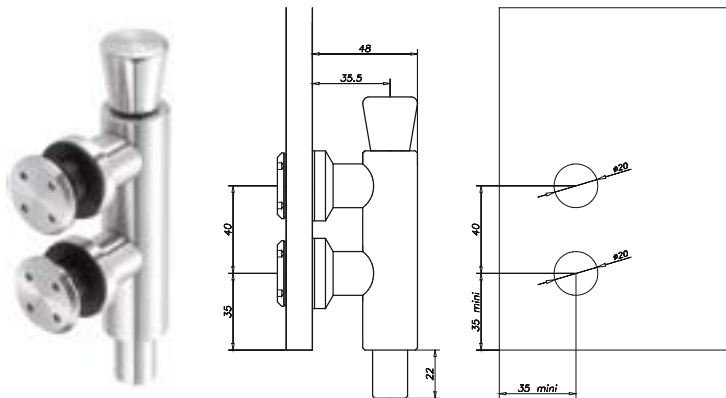

8 → 12 mm

09 90 03 05

Profil de serrage du verre pour panneau fixe avec cache
Glass tightening profile for fixed panel with cover

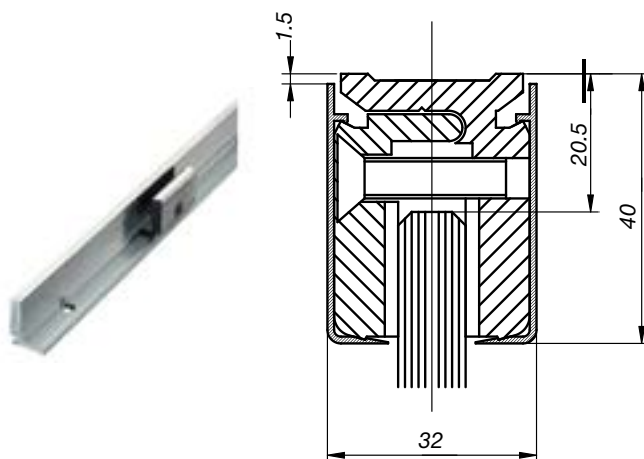

8 mm

09 94 KL01 R08

10 mm

09 94 KL01 R10

12 mm

09 94 KL01 R12

Autres épaisseurs de verre sur commande / Other glass thicknesses on order
Plus d'informations techniques sur sadev.com / More information on sadev.com

FICHES TECHNIQUES SUR
sadev.com
TECHNICAL INFORMATION ON
sadev.com

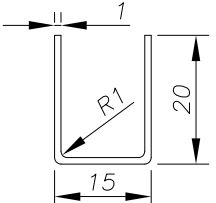
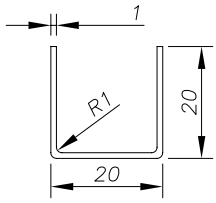
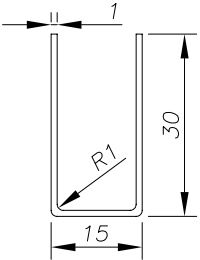
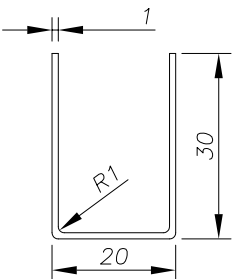
PHOTO PHOTO	ENCOMBREMENT DIMENSIONS	LONGUEUR STANDARD LENGTH	RÉFÉRENCE REFERENCE
	Profil U plié 20×15×1 mm / <i>Folded U-section 20×15×1 mm</i>		
		100 cm	09 90 20 15 1-100
		200 cm	09 90 20 15 1-200
		300 cm	09 90 20 15 1-300
	Profil U plié 20×20×1 mm / <i>Folded U-section 20×20×1 mm</i>		
		100 cm	09 90 20 20 1-100
		200 cm	09 90 20 20 1-200
		300 cm	09 90 20 20 1-300
	Profil U plié 30×15×1 mm / <i>Folded U-section 30×15×1 mm</i>		
		100 cm	09 90 30 15 1-100
		200 cm	09 90 30 15 1-200
		300 cm	09 90 30 15 1-300
	Profil U plié 30×20×1 mm / <i>Folded U-section 30×20×1 mm</i>		
		100 cm	09 90 30 20 1-100
		200 cm	09 90 30 20 1-200
		300 cm	09 90 30 20 1-300

Autres épaisseurs de verre sur commande / *Other glass thicknesses on order*
Plus d'informations techniques sur sadev.com / *More information on sadev.com*

i FICHES TECHNIQUES SUR
sadev.com
TECHNICAL INFORMATION ON
sadev.com

PHOTO PHOTO	ENCOMBREMENT DIMENSIONS	RÉFÉRENCE REFERENCE
----------------	----------------------------	------------------------

Clé de serrage compas / *Compass tightening wrench*

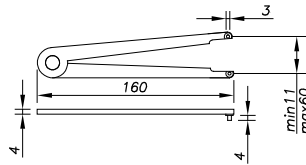

09 758 11 60

Clé de serrage cylindrique / *Cylindrical tightening wrench*

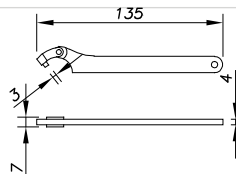

09 776 C20 35

PHOTO PHOTO	POIDS WEIGHT	DIAMÈTRE DIAMETER	RÉFÉRENCE REFERENCE
----------------	-----------------	----------------------	------------------------

Forets de perçage spéciaux pour inox / *Special drill bits for stainless steel*



30 g	4,2	09 90 01 42
55 g	6,1	09 90 01 61
75 g	8,2	09 90 01 82

PHOTO PHOTO	POIDS WEIGHT	TARAUDAGE TAPPING	RÉFÉRENCE REFERENCE
----------------	-----------------	----------------------	------------------------

Tarands machine / *Machine taps*



25 g	M4	09 90 02 M4
45 g	M5	09 90 02 M5

PHOTO PHOTO	POIDS WEIGHT	Ø / LONGUEUR Ø / LENGTH	RÉFÉRENCE REFERENCE
----------------	-----------------	----------------------------	------------------------

Goupille élastique inox / *Stainless steel elastic pin*



20 g	4x20	09 90 03 420
42 g	6x35	09 90 03 635
60 g	8x50	09 90 03 850

Autres épaisseurs de verre sur commande / *Other glass thicknesses on order*
Plus d'informations techniques sur **sadev.com** / *More information on sadev.com*

**SUPPORTS D'ÉTAGÈRES
SHELF SYSTEM**

 FICHES TECHNIQUES SUR sadev.com
TECHNICAL INFORMATION ON sadev.com

Les supports d'étagères pour montage sur chandelle vous permettent d'installer des parois vitrées (sanitaire par exemple) de petite dimension. Cette solution permet un nettoyage facile grâce à l'accès sous le vitrage.

Shelf supports for fitting on pin are used for reduced glass walls dimensions (toilets for example). Easy to clean thanks to the access under the glass.

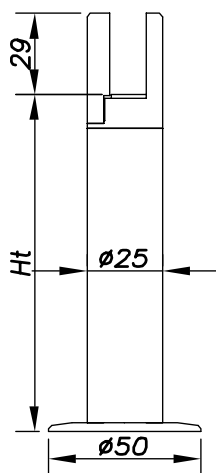
PHOTO PHOTO	ENCOMBREMENT DIMENSIONS	HAUTEUR HEIGHT	EPAISSEUR DE VERRE GLASS THICKNESS	RÉFÉRENCE REFERENCE
Support d'étagère montage sur chandelle / Shelf support for fitting on pin				
 	71 mm	6 mm	08 91 81 V6	
		8 mm	08 91 81 V8	
		10 mm	08 91 81 V10	
		12 mm	08 91 81 V12	
	91 mm	6 mm	08 91 82 V6	
		8 mm	08 91 82 V8	
		10 mm	08 91 82 V10	
		12 mm	08 91 82 V12	
	121 mm	6 mm	08 91 83 V6	
		8 mm	08 91 83 V8	
		10 mm	08 91 83 V10	
		12 mm	08 91 83 V12	
171 mm	6 mm	08 91 84 V6		
	8 mm	08 91 84 V8		
	10 mm	08 91 84 V10		
	12 mm	08 91 84 V12		

Autres épaisseurs de verre sur commande / Other glass thicknesses on order
Plus d'informations techniques sur sadev.com / More information on sadev.com

